

SG PROGRAM	1-11
LED VANJSKA	12-13
ZIDNA VANJSKA	14-18
STROPNA VANJSKA	19
LED ZIDNA NADGRADBENA	20-25
LED FLAT ZIDNA	26
ZIDNA UGRADBENA	27-28
ZIDNA VANJSKA	29
ZIDNA/PLAFONJERA VANJSKA	30
ZIDNA/PLAFONJERA VANJSKA SA SENZ.	31
LED VANJSKA/VANJSKA SENZOR	32
PODNA UGRADBENA	33
PODNA UGR. LED KOCKA	34-35
PODNA VANJSKA	36
PODNA/ZIDNA VANJSKA	37-41
PODNA/VISILICA VANJSKA	42-43
LANTERNA	44-54
LED REFLEKTORI	55-57
LED VANJSKA	58-59
LED VODOTIJESNA IP65	60
VODOTIJESNA IP65	61
AKCIJA	62-78

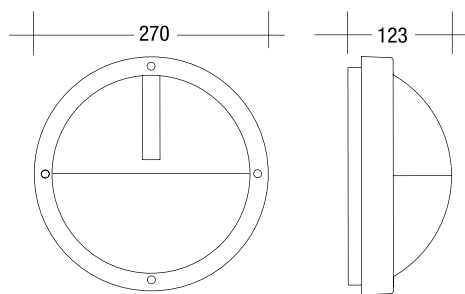

Design: Hallvard Jakobsen

Product Details:
Technical Specifications

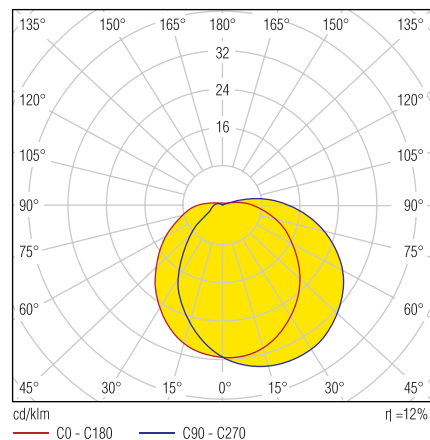

IP65

IK10

▪ **UNO WHITE**

E-27



▪ **UNO GRAPHITE**

E-27



▪ **PRIMO WHITE**

26W TC-D G24d-3

E-27 60W

Product Details:
Technical Specifications

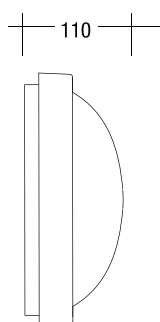

IK10  **IP65**



Design: Hallvard Jakobsen

▪ **PRIMO GRAPHITE**

26W TC-D G24d-3

E-27 60W



▪ **PRIMO BLACK**

26W TC-D G24d-3

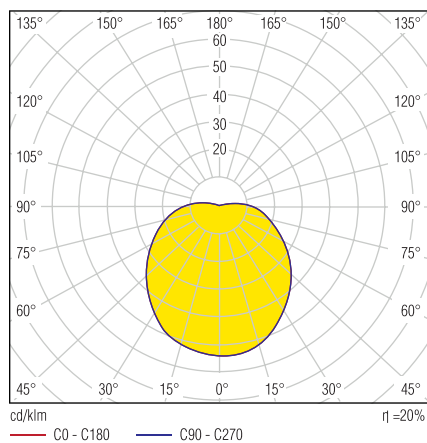

IK10  **IP65** **CE** 

▪ BALLAD WHITE

E-27 60W

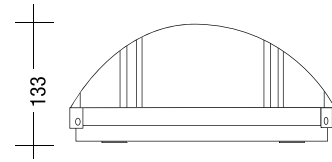

Product Details:
Technical Specifications

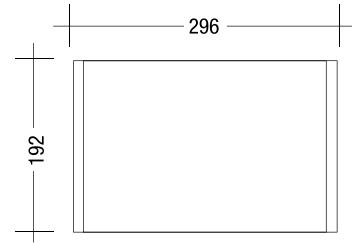

IP64

IK10

▪ BALLAD SILVER

E-27 60W



▪ BALLAD GRAPHITE

E-27 60W



▪ BALLAD BLACK

26W TC-D G24d-3

E-27 60W



Design: Birger Sevaldson



Product Details:
Technical Specifications

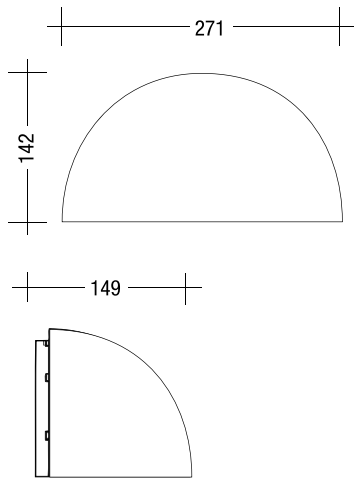
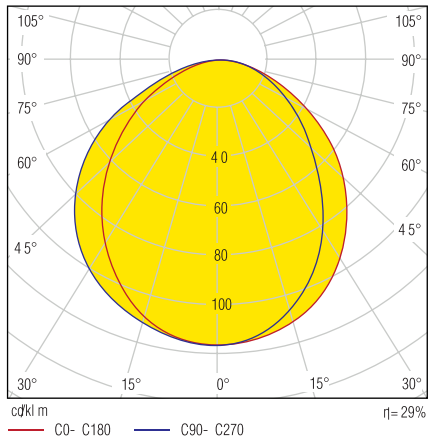

IK10  **IP65**



Design: Svein Knutsen

▪ **DUETT WHITE**

E-27 60W



▪ **DUETT GRAPHITE**

18W TC-D G24d-3

E-27 60W



▪ **DUETT BLACK**

18W TC-D G24d-3

E-27 60W



▪ TARDO WHITE

26W TC-D G24d-3

E-27 60W



▪ TARDO GRAPHITE

E-27 60W



Design: Andrew Smith

Product Details:
Technical Specifications

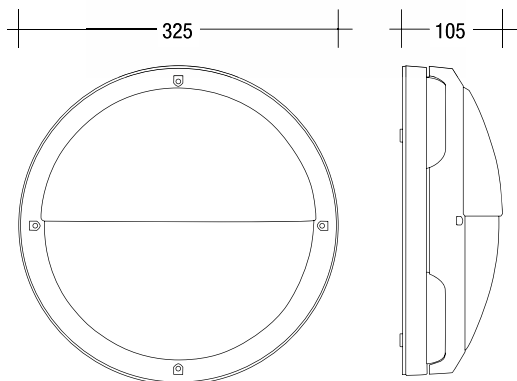

IK10  IP65

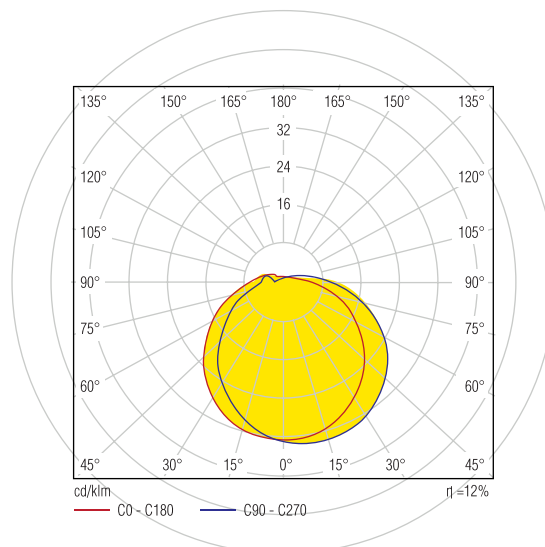

▪ DISCOS WHITE

2x26W TC-D G24d-3

2XE-27 60W



▪ DISCOS GRAPHITE

2XE-27 60W

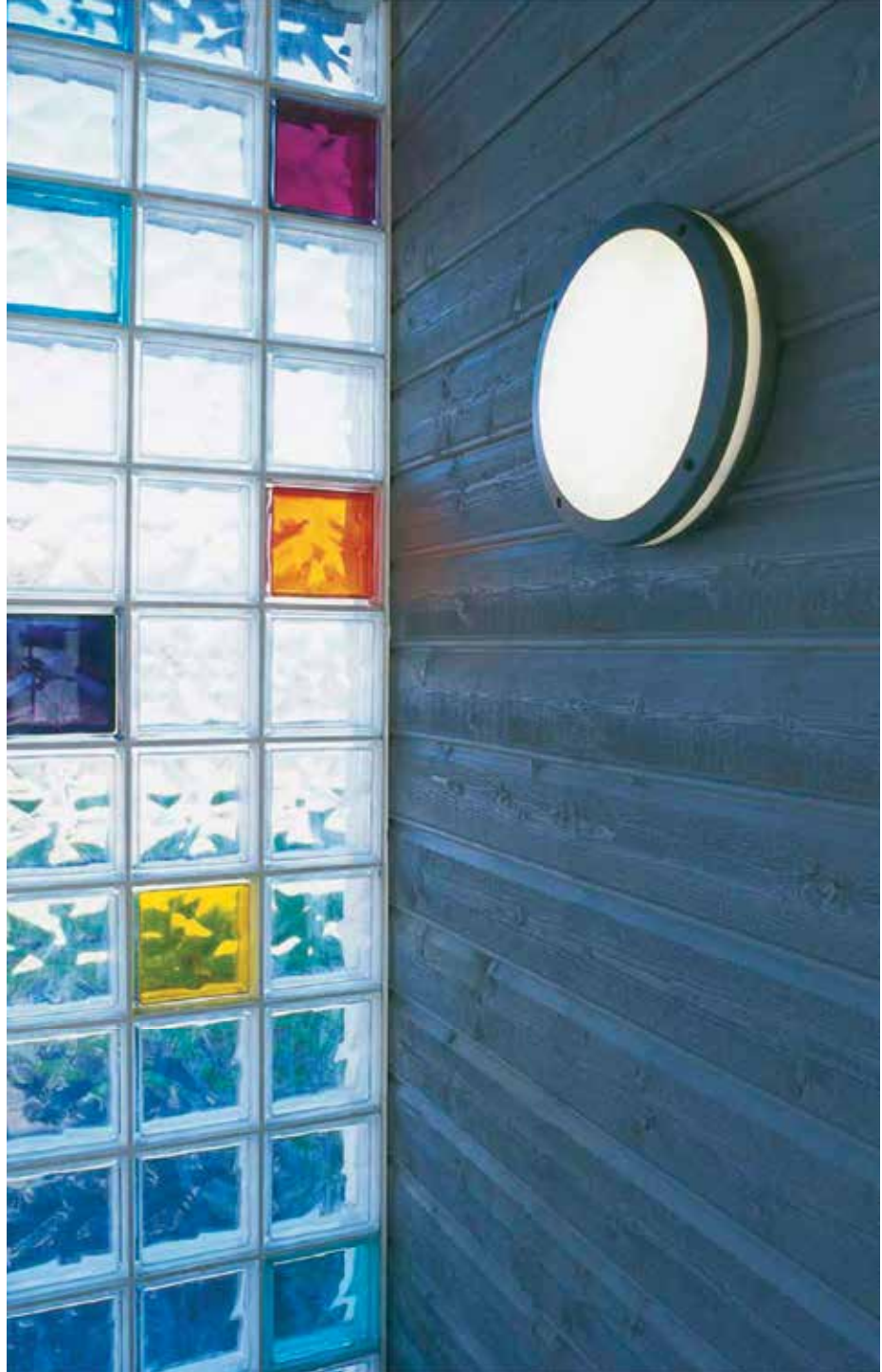

Design: Hallvard Jakobsen

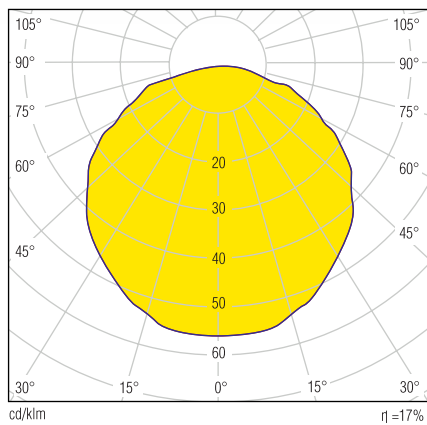

DISCOS

Product Details:
Technical Specifications

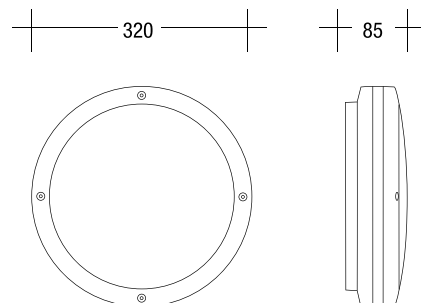

IP65

IK10



▪ LINK WHITE

2x18W TC-D G24d-2

E-27 60W



▪ LINK GRAPHITE

2x18W TC-D G24d-2

E-27 60W



Product Details:
Technical Specifications

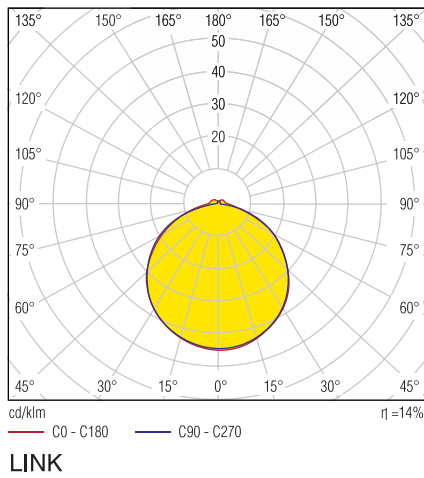

IP65
IK10



Design: Hallvard Jakobsen

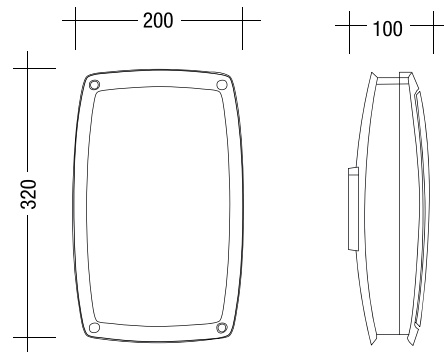

▪ SIDEWALK WHITE

2x26W TC-D G24d-3

2xE-27 60W



▪ SIDEWALK GRAPHITE

2xE-27 60W



Product Details:
Technical Specifications

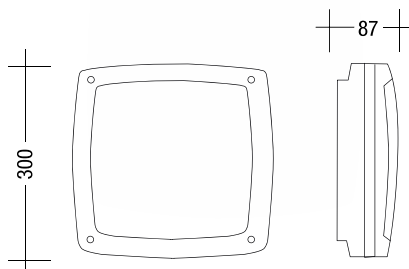
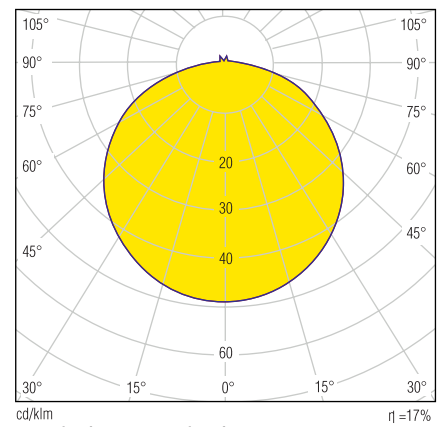

IK10  **IP65**

▪ TRIO E27
WHITE

611520



▪ TRIO E27
GRAPHITE

623520



▪ TRIO E27 GALVANIZED

691520



Product Details:
Technical Specifications

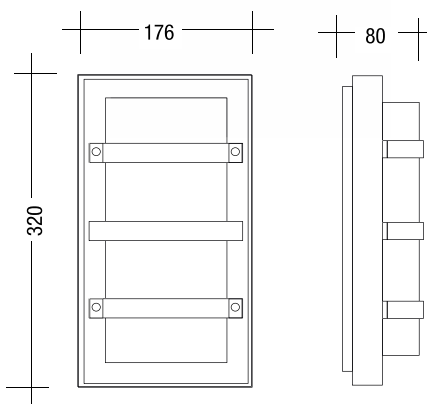

IK10  **IP65**



▪ ALTO 2xE27
WHITE

611370A



▪ ALTO 2xE27
GRAPHITE

623370A



Product Details:
Technical Specifications

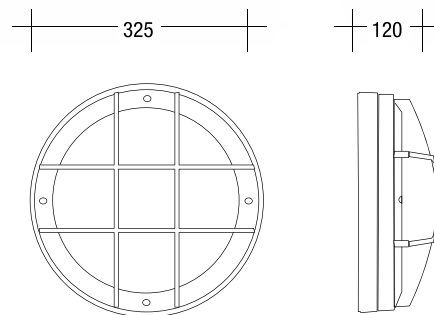

IK10  **IP65**

▪ LARGO E27 WHITE

611560



▪ LARGO E27 GRAPHITE

623560



▪ LARGO E27 GALVANIZED

691560



Product Details:
Technical Specifications

CE  IK10  IP65

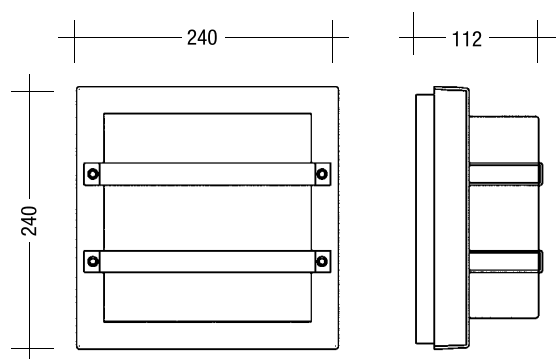

▪ SPIDER 2xE27
WHITE

611676A



▪ SPIDER 2xE27
GRAPHITE

623676A



Product Details:
Technical Specifications

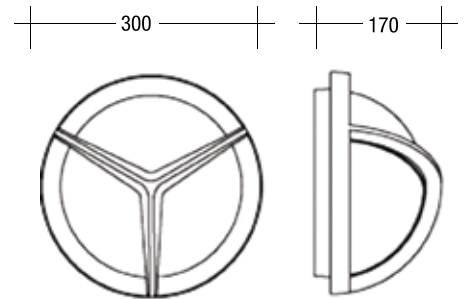

IP64 IK10



▪ SPINET 2xE27 WHITE

611671A



▪ SPINET 2xE27 GRAPHITE

623671A



Product Details:
Technical Specifications

IP64 IK10

▪ CDR020401 alu-dark grey

- Ø200*45mm, 3000K
- Die-casting aluminium body in dark grey powder coated
- PC diffuser
- IP54
- 240V, SMD LEDS, 10W
- TUV approved LED driver
- White box package+product label



▪ CDR020402 alu-dark grey

- 200*200*45mm, 3000K
- Die-casting aluminium body in dark grey powder coated
- PC diffuser
- IP54
- 240V, SMD LEDS, 10W
- TUV approved LED driver
- White box package+product label



▪ 2605S DARK GREY

270x270x60mm, IP65, LED 18W, 3000K ABS+PC

▪ 2605M DARK GREY

320x320x60mm, IP65, LED 24W, 3000K ABS+PC

▪ 2601M DARK GREY

280x280x60mm, IP65, LED 24W, 3000K ABS+PC

▪ 2605L DARK GREY

330x330x60mm, IP65, LED 36W, 3000K ABS+PC





▪ 91211 GREY | WHITE

15W E27 CFL,
Aluminium and PC diffuser



Product Details:
Technical Specifications

IP54

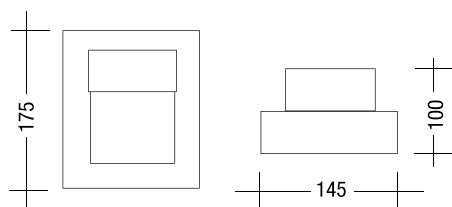

▪ 91218 GREY | WHITE

18W E27 CFL,
Aluminium and PC diffuser



Product Details:
Technical Specifications

IP54

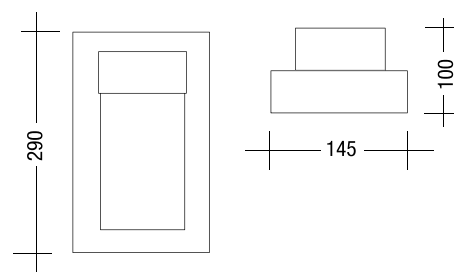

▪ 91215 GREY | WHITE

18W E27 CFL, Aluminium and PC diffuser



Product Details:
Technical Specifications

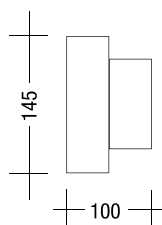
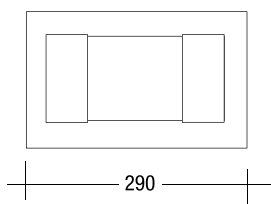

IP54



▪ 91217 GREY | WHITE

18W E27 CFL, Aluminium and PC diffuser



Product Details:
Technical Specifications

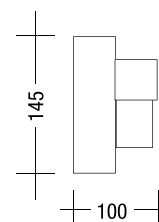
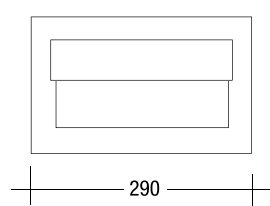

IP54



▪ WM002 DARK GREY ANTRACITE
| MATT WHITE

GU10 Max 2xMax 35W, Class 1
Aluminium body, Tempered glass diffuser, silicone gasket

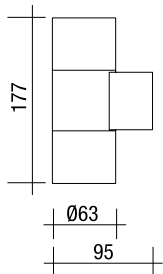

IP65

▪ WM001 DARK GREY ANTRACITE
| MATT WHITE

GU10 Max 50W, Class 1
Aluminium body, Tempered glass diffuser, silicone gasket

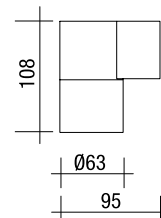

IP65

▪ CDR020204 ALU DARK GREY

240V, 6W, 3000K

▪ CDR020204S ALU DARK GREY

240V, 2*6W, 3000K

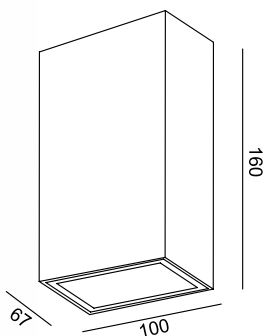

IP54

- Die-casting body in dark grey powder coated finish
- Tempered glass
- 240V CREE LED 1304, 6W / 2*6W
- Perfect led reflector included
- TUV approved led driver
- White box package+product label



▪ WM051 DARK GREY ANTRACITE
| MATT WHITE

GU10 MAX50W, Class 1, Aluminium die casting body,
Tempered glass diffuser, silicone gasket



Product Details:
Technical Specifications

IP54

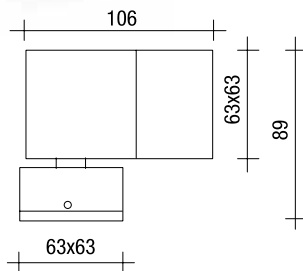

▪ WM052 DARK GREY ANTRACITE
| MATT WHITE

GU10 2xMAX35W, Class 1, Aluminium die casting body,
Tempered glass diffuser, silicone gasket



Product Details:
Technical Specifications

IP54

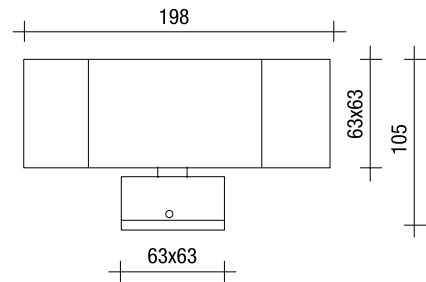

▪ WM053 DARK GREY ANTRACITE
| MATT WHITE

GU10 2xMAX35W, Class 1, Aluminium die casting body,
Tempered glass diffuser, silicone gasket



Product Details:
Technical Specifications

IP54

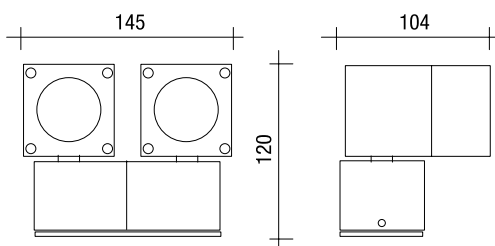

▪ WM055 DARK GREY ANTRACITE
| MATT WHITE

GU10 2xMAX35W, Class 1, Aluminium die casting body,
Tempered glass diffuser, silicone gasket



Product Details:
Technical Specifications

IP54

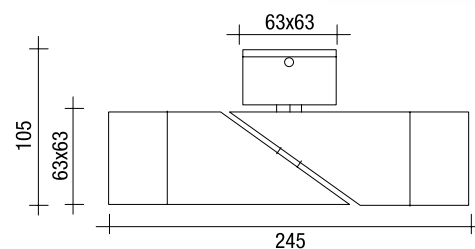

▪ WM042 DARK GREY ANTRACITE
| MATT WHITE

GU10 MAX 50W, Class 1, Aluminium die casting body,
Tempered glass diffuser, silicone gasket

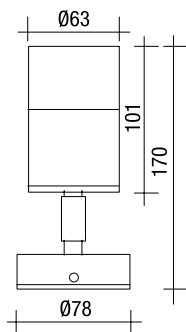

Product Details:
Technical Specifications

IP54

▪ WM043 DARK GREY ANTRACITE
| MATT WHITE

GU10 2 x MAX 35W, Class 1, Aluminium die casting body,
Tempered glass diffuser, silicone gasket

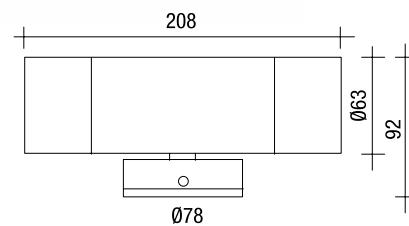

Product Details:
Technical Specifications

IP54



▪ XK1001 WHITE

IP54, GU10, dim: 85x85xh=66mm



▪ XK1001 ANTRACIT

IP54, GU10, dim: 85x85xh=66mm



▪ CDR020231 ALU DARK GREY

IP54, 240V, COB LED, 10W, 3000K



- Pure aluminium body in dark grey powder coated
- Tempered glass
- 240V COB LED, 10W
- Perfect led reflector included
- TUV approved led driver
- White box package+product label

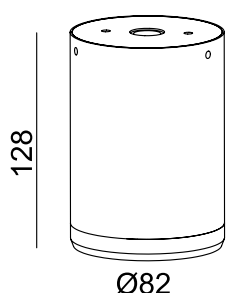

▪ XK1002 WHITE

IP54, GU10, dim: Ø=90, h=62mm



▪ XK1002 ANTRACIT

IP54, GU10, dim: Ø=90, h=62mm



▪ CDR020261 ALU DARK GREY

240V, SMD LEDS, 2*5W, 3000K

Product Details:

Technical Specifications

- Die-casting aluminium dark grey powder coated
- PC diffuser
- IP54
- TUV approved LED driver
- White box package+product label

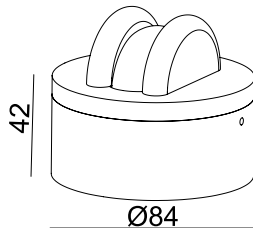
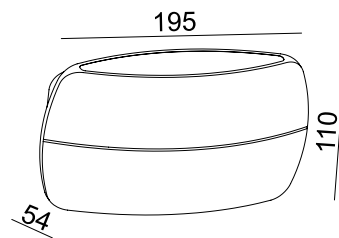

▪ CDR020231 ALU DARK GREY

240V, CREE LED, 7W, 1700K

Product Details:

Technical Specifications

- Pure aluminium body in dark grey powder coated
- Perfect led lens
- IP65
- TUV approved LED driver
- White box package+product label

▪ CDR020391 ALU DARK GREY

240V, SMD LEDS, 7W, 3000K, Ø150*50mm

Product Details:

Technical Specifications

- Die-casting aluminium body in dark grey powder coated
- PC diffuser
- IP54
- TUV approved LED driver
- White box package+product label



▪ SR2304S DARK GREY

140x140x50.5mm, IP65, LED 6W, 3000K



▪ SR9401 DARK GREY

178x28x90mm, IP65, LED 2x3W, 3000K



▪ SR81206 DARK GREY

220x170x50mm, IP65, LED 12W, 3000K



▪ SR8005 DARK GREY

200x60x120mm, IP65, LED 7W, 3000K





▪ SR170 DARK GREY-ANTRACITE

LED 230V 6W



▪ SR171 DARK GREY-ANTRACITE

LED 230V 6W



▪ SR170 WHITE

LED 230V 6W



▪ SR171 WHITE

LED 230V 6W



▪ SR1601L WHITE

LED 230V 6W



▪ SR1601L DARK GREY-ANTRACITE

LED 230V 6W

Product Details:
Technical Specifications

Model	SR170	SR171	SR1601L
Size	130x30x60mm	220x30x70mm	170x60x70mm
Light colour	3000K	3000K	3000K
Material	Aluminium	Aluminium	Aluminium
Protection class	IP54	IP54	IP54





▪ SR181

WALL LAMP / WHITE

Product Details:
Technical Specifications

Model:	SR181 WHITE	SR181 ANTRACIT
Wattage:	3,5W	3,5W
Voltage:	AC220-240V	AC220-240V
IP:	54	54

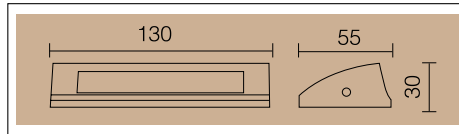

▪ SR181

WALL LAMP / ANTRACIT



▪ SR16011T

LED 2x2W

Product Details:
Technical Specifications

Model	SR16011T	SR16011F
Size	110x110mm	100x100mm
Light colour	4000K	4000K
Beam angle	up10° down40°	4x10°
Watt	2x2W	4x1W



▪ SR16011F

LED 4x1W



▪ P1101 SILVER SIVA
| ANTRACIT SIVA | MAT BIJELA

LED



Product Details:
Technical Specifications

Material	PC + ABS & PC diffuser
Lighting Technology	3014 LED 20 PCS
Lumen	100Lm
Protection Class	IP44, CLASS II
Voltage	230V/AC

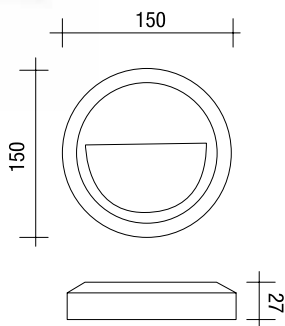

▪ P1201 SILVER SIVA
| ANTRACIT SIVA | MAT BIJELA

LED



Product Details:
Technical Specifications

Material	PC + ABS & PC diffuser
Lighting Technology	3014 LED 16 PCS
Lumen	80Lm
Protection Class	IP44, CLASS II
Voltage	230V/AC

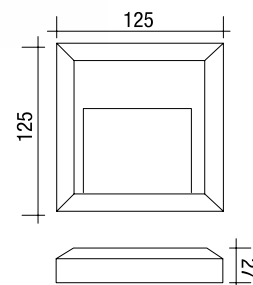

▪ P1502 SILVER SIVA | ANTRACIT SIVA
| MAT BIJELA

LED



Product Details:
Technical Specifications

Material	PC + ABS & PC diffuser
Lighting Technology	3014 LED 35PCS
Lumen	160 Lm
Protection Class	IP65, CLASS II
Voltage	230V/AC

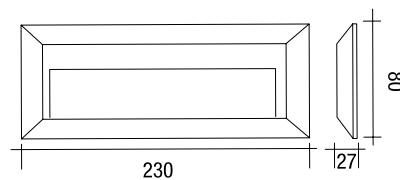



▪ P1501 ANTRACITE

WALL LAMP

Product Details:
Technical Specifications

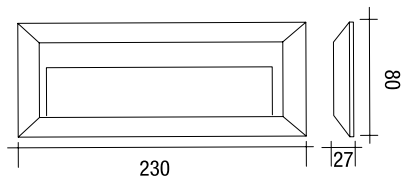

▪ P1501 WHITE

WALL LAMP

Product Details:
Technical Specifications

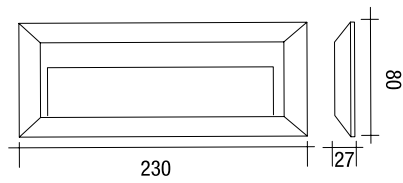



▪ RUEDA SHORT
STAINLESS STEEL
IP56

WALL LED LIGHT

Product Details:
Technical Specifications

- COLOR (K): warm white
- DIMENZIJE: Ø73*10,5
- KUTIJA ZA UGRADNJU: Ø60



▪ TANGO SHORT
STAINLESS STEEL
IP56

WALL LED LIGHT

Product Details:
Technical Specifications

- COLOR (K): warm white
- DIMENZIJE: 73*73*10,5
- KUTIJA ZA UGRADNJU: Ø60



▪ SALSA SHORT
MATT BRASS
IP66 0,8W

WALL LED LIGHT

Product Details:
Technical Specifications

- COLOR (K): warm white
- DIMENZIJE: 73*73
- KUTIJA ZA UGRADNJU: Ø60



▪ POWER SUPPLY
TYPE ZOL 7

RATED POWER 7W

Product Details:
Technical Specifications

- IP44
- DIMENZIJE: Ø53x25
- KUTIJA ZA UGRADNJU: Ø60



▪ POWER SUPPLY
TYPE ZOL 15

RATED POWER 15W

Product Details:
Technical Specifications

- IP44
- DIMENZIJE: Ø53x32
- KUTIJA ZA UGRADNJU: Ø60



▪ POWER SUPPLY
TYPE ZOL 6

RATED POWER 6W

Product Details:
Technical Specifications

- IP65
- DIMENZIJE: 93x35x22

▪ LED-IP65-SMD-SPOT LIGHT 3000K

230V, 5W, ROUND WHITE

▪ LED-IP65-SMD-SPOT LIGHT 4000K

230V, 5W, ROUND WHITE

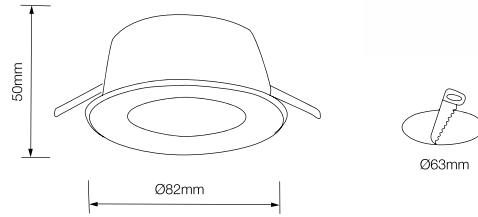

▪ 1501 BOX WHITE
| BOX GREY | BOX BLACK
| BOXS/S INOX

220~240V, 60W, 50Hz, IP54, E-27



▪ 1502 BOX WHITE
| BOX GREY | BOX BLACK
| BOXS/S INOX

220~240V, 60W, 50Hz, IP54, E-27



Product Details:
Technical Specifications

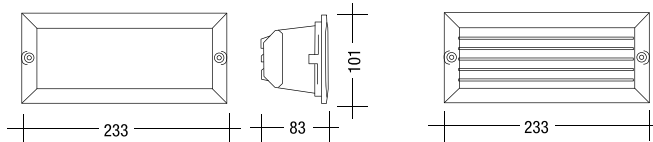

▪ TO1541 BLACK | GREY | WHITE

220~240V, 60W, 50Hz, IP54, E-27



Product Details:
Technical Specifications

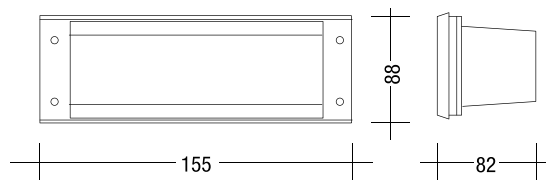

▪ TO1544 GREY | BLACK | WHITE

220~240V, 60W, 50Hz, IP54, E-27



Product Details:
Technical Specifications

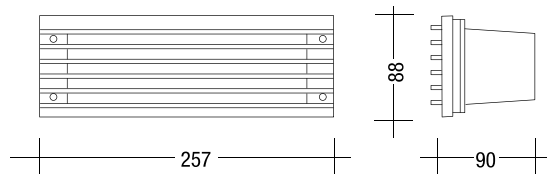

▪ 1801 BLACK | GREY | WHITE

220~240V, 75W, 50Hz, IP54, E-27



Product Details:
Technical Specifications

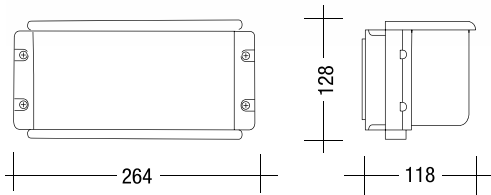

▪ 1803 GREY | BLACK | WHITE

220~240V, 75W, 50Hz, IP54, E-27



Product Details:
Technical Specifications

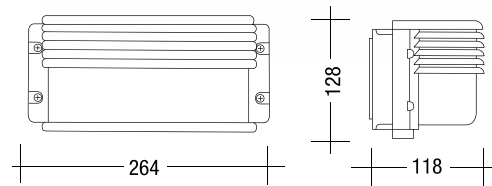

▪ 1603 WHITE
| GREY | BLACK

220~240V, 60W, 50Hz, IP54, E-27

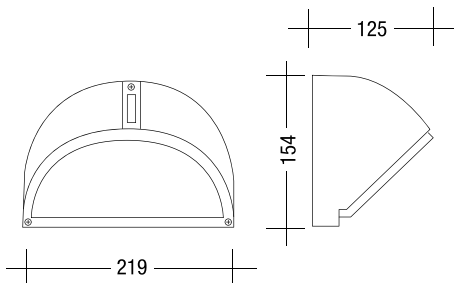

Product Details:
Technical Specifications



▪ 1202 WHITE

220~240V, 100W, 50Hz, IP54, E-27

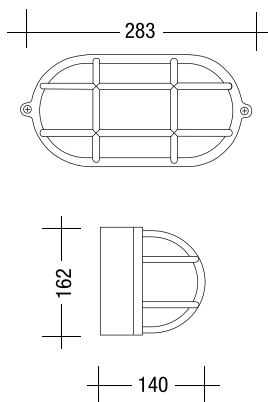

▪ 1402 BLACK | WHITE

220~240V, 60W, 50Hz, IP54, E-27



Product Details:
Technical Specifications

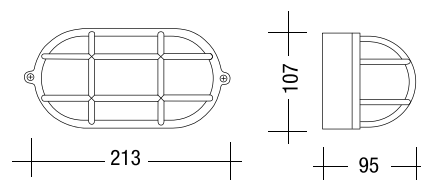

▪ 2101 WHITE | GREY

220~240V, 100W, 50Hz, IP54, E-27



Product Details:
Technical Specifications

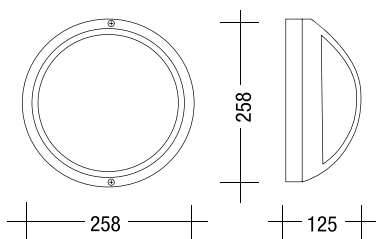

ST 705 A SENZOR

110-130V/AC 220-240V/AC, E27 MAX 60W



Product Details:

Technical Specifications

Detection Range	360°
Additional Switching Capacity	300W
Detection Distance	1-8m (radius) adjustable
Time Delay	10sec±3sec to 12min±1min (adj.)
Ambient Light	<3-2000LUX (adj.) IP44, IK10

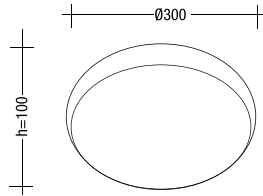

ST 69 ANTRACITE GREY | WHITE

Infrared Sensor Lamp

220-240V/AC 60W Max 180°



Product Details: Technical Specifications



IP 44



Model	LX81
Detection range	(22°C):<180°
Detection distance	5-7m(max)(24°C)
Power sources	220~240V/AC 110~130V/AC
Power frequency	50/60Hz
load	incandescent lamp 60W (230V/AC)
Time-delay	min:8sec±3sec max:3Min±1Min
Ambient light	10LUX~sunshine
Working temperature	-10°C~+40°C

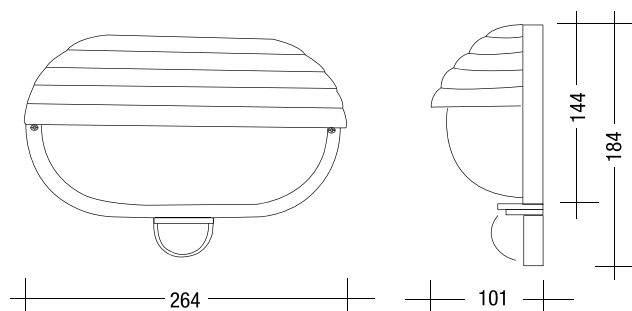

▪ LED-BL-MY2S14XA1

AC220-240V, 14W, 4000K, 1000lm, IP54,
215*215*80mm, 120°, 71.4lm/W



▪ LED-BL-MT1S14XA1

AC220-240V, 14W, 4000K, 1000lm, IP54,
212*119*60.5mm, 120°, 71.4lm/W



▪ LED-BL-MY2S14XA2

AC220-240V, 14W, 4000K, 600lm, IP54,
215*215*80mm, 120°, 42.9lm/W



▪ LED-BL-MY2S14DA1-B8
PIR SENSOR

AC220-240V, 14W, 4000K, 1000lm, IP54,
215*215*80mm, 120°, 71.4lm/W



▪ LED-BL-MT1S14DA1-B8
PIR SENSOR

AC220-240V, 14W, 4000K, 1000lm, IP54,
212*119*60.5mm, 120°, 71.4lm/W



▪ LED-BL-MY2S14DA2-B8 PIR SENSOR

AC220-240V, 14W, 4000K, 600lm, IP54, 215*215*80mm, 120°, 42.9lm/W



▪ 3707-A S/S INOX

220-240V, 150W, 50Hz, IP67, E-27



Product Details:
Technical Specifications

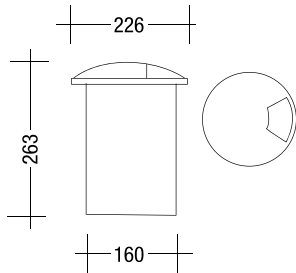

▪ CDR040027 S/S316+ALU

240V, GU10, Max 35W

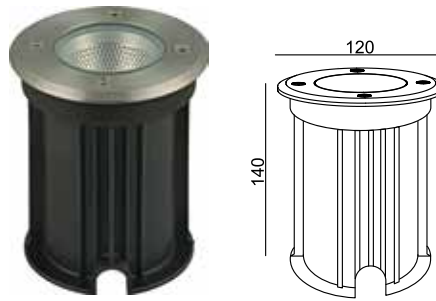

Product Details:
Technical Specifications

- Stainless steel top frame+die casting aluminium body
- Tempered glass difuser
- IP66
- 0,38m VDE approved cable included. Two table glands.
- White box package+product label



▪ LD0052B S/S INOX

12V, 50W, 50Hz, IP65, G5,3



Product Details:
Technical Specifications

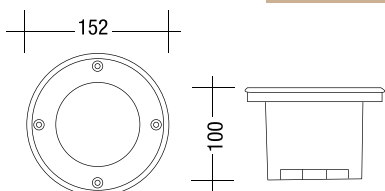

▪ LD0011B S/S INOX

12V, 35W, 50Hz, IP65, G5,3



Product Details:
Technical Specifications

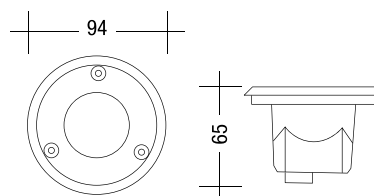

▪ LED BRICK 100X100

▪ LED BRICK 200X200

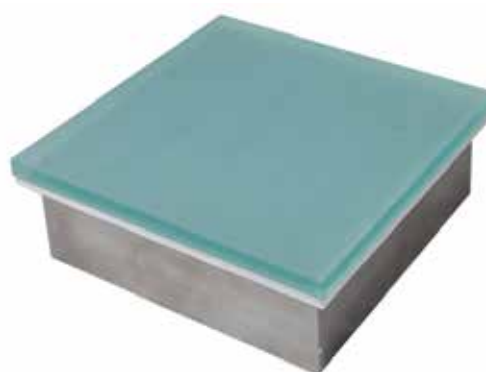
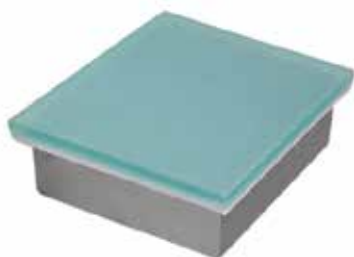

Product Details:
Technical Specifications

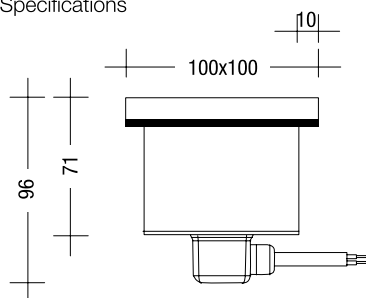

Product Details:
Technical Specifications

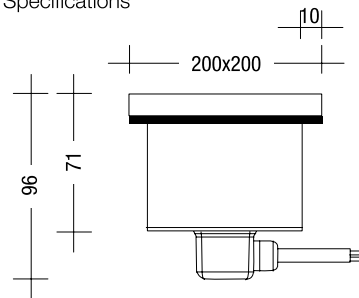

Model	LED BRICK 100X100	LED BRICK 200X200
Voltage	Input: 24vdc, current: 50mA	Input: 24vdc, current: 146mA
Power	1.2 W	3.5 W
Colour	Single Color, RGB	Single Color, RGB
Waterproof	IP67	IP67
Working Temperature	-20°C~+60°C	-20°C~+60°C
Working life expectancy	>20000 hours, non-toxic, non-polluting and environmental friendly, double layer sealed, stainless steel base, sealed with silica gel inside for effective waterproof	>20000 hours, non-toxic, non-polluting and environmental friendly, double layer sealed, stainless steel base, sealed with silica gel inside for effective waterproof



▪ LED BRICK 200X100

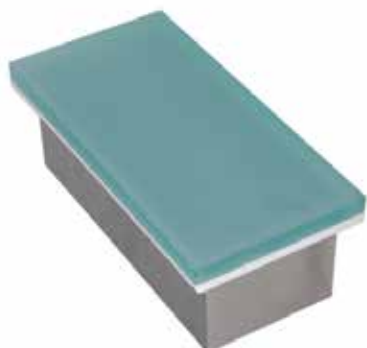

Product Details:
Technical Specifications

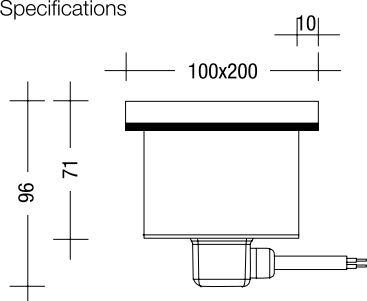

Model	LED BRICK 200X100
Voltage	Input: 24vdc, current: 95mA
Power	2,3 W
Colour	Single Color, RGB
Waterproof	IP67
Working Temperature	-20°C~+60°C
Working life expectancy	>20000 hours, non-toxic, non-polluting and environmental friendly, double layer sealed, stainless steel base, sealed with silica gel inside for effective waterproof



WW12105 ANTR. GREY

LED 3W IP65



Product Details:
Technical Specifications

WW12105
A-66mm
B-100mm

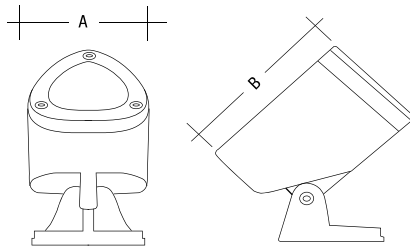

TL3011 BLACK
| GREY | WHITE

12V, 35W, 50Hz, IP68, G5,3



Product Details:
Technical Specifications

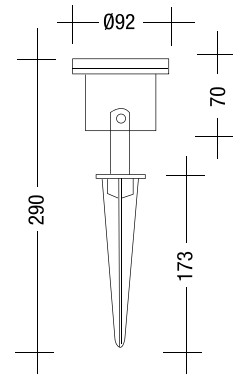

WM075 MAT WHITE

GU10, h=108mm, Ø=63mm



WM075 DARK GREY/ANTRACITE

GU10, h=108mm, Ø=63mm



▪ GL11607 ANTR. GREY

LED 6W IP54



Product Details:
Technical Specifications

GL11607
A-125mm
B-500mm
C-210mm

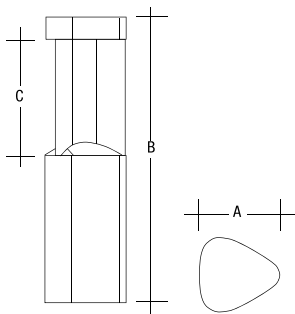

▪ GL11602 ANTR. GREY

LED 6W IP54



Product Details:
Technical Specifications

GL11602
A-125mm
B-800mm
C-300mm

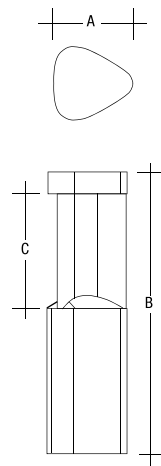

▪ GL11604 ANTR. GREY

LED 6W IP54



Product Details:
Technical Specifications

GL11604
A-170mm
B-200mm
C-100mm

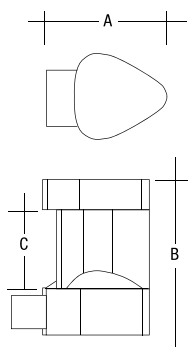

▪ SR 1711 ANTRACIT GREY

LED 9W IP54

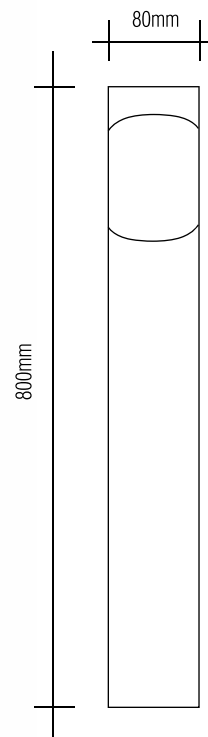

▪ GL11206 ANTR. GREY

LED 6W IP54

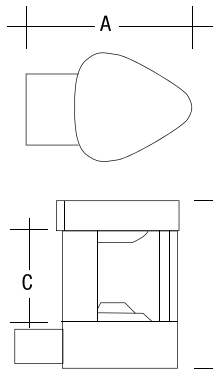

Product Details:
Technical Specifications

GL11206
A-170mm
B-200mm
C-100mm

▪ GL11204
ANTR. GREY

LED 6W IP54



▪ GL11205
ANTR. GREY

LED 6W IP54

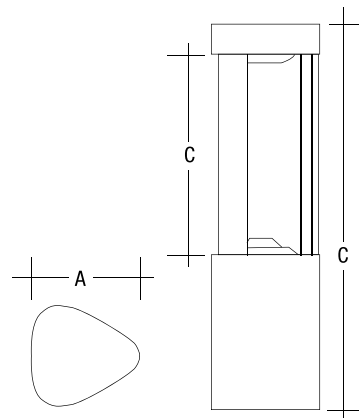
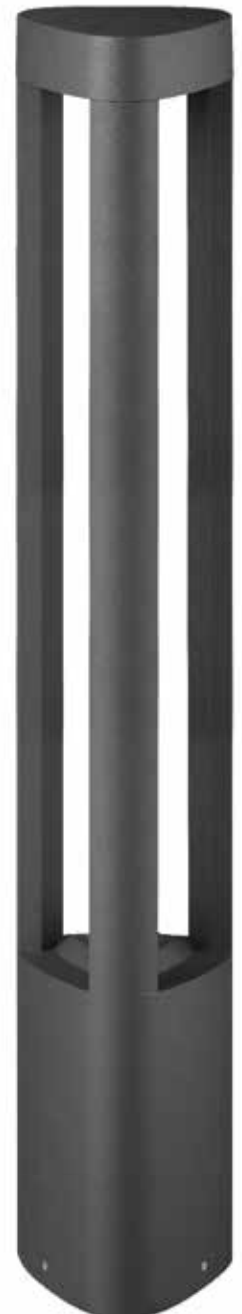

Product Details:
Technical Specifications

GL11204	GL11205
A-125mm	A-125mm
B-500mm	B-800mm
C-260mm	C-560mm

▪ GL12401
DARK GREY ANTRACITE

E27/MAX. 60W IP54, h=300, 120x120mm



▪ GL12402
DARK GREY ANTRACITE

E27/MAX. 60W IP54, h=500, 120x120mm



▪ GL12403
DARK GREY ANTRACITE

E27/MAX. 60W IP54, h=800, 120x120mm



▪ GL12404
DARK GREY ANTRACITE

E27/MAX. 60W IP54, h=250, 120x120mm





▪ GL11307 ANTR. GREY

E-27 23W IP54



▪ GL11306 ANTR. GREY

E-27 23W IP54

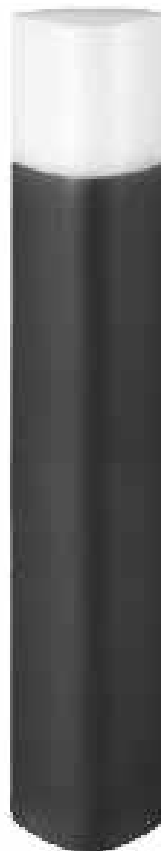

▪ GL11305 ANTR. GREY

E-27 23W IP54



Product Details:
Technical Specifications

Model	A	B
GL11305	125	500
GL11306	125	800
GL11307	170	250

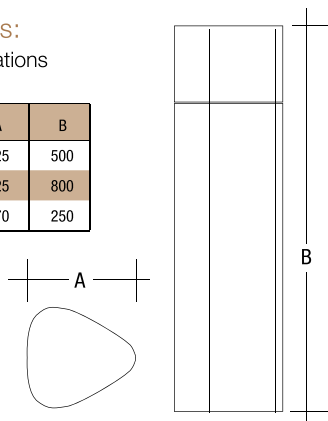

▪ GL11404 ANTR. GREY

E-27 23W IP54



▪ GL11402 ANTR. GREY

E-27 23W IP54



▪ GL11403 ANTR. GREY

E-27 23W IP54



Product Details:
Technical Specifications

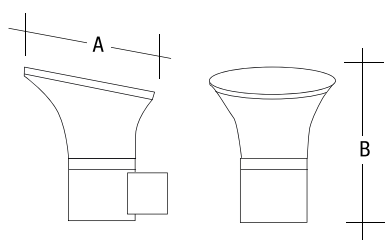
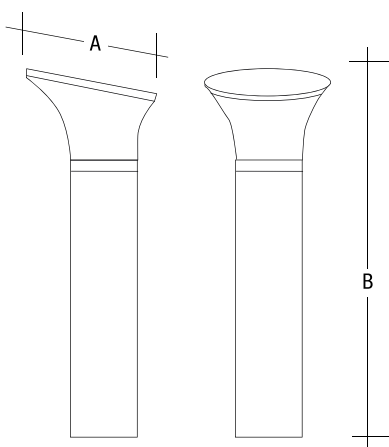

Model	A	B
GL11402	175	500
GL11403	175	800
GL11404	170	200

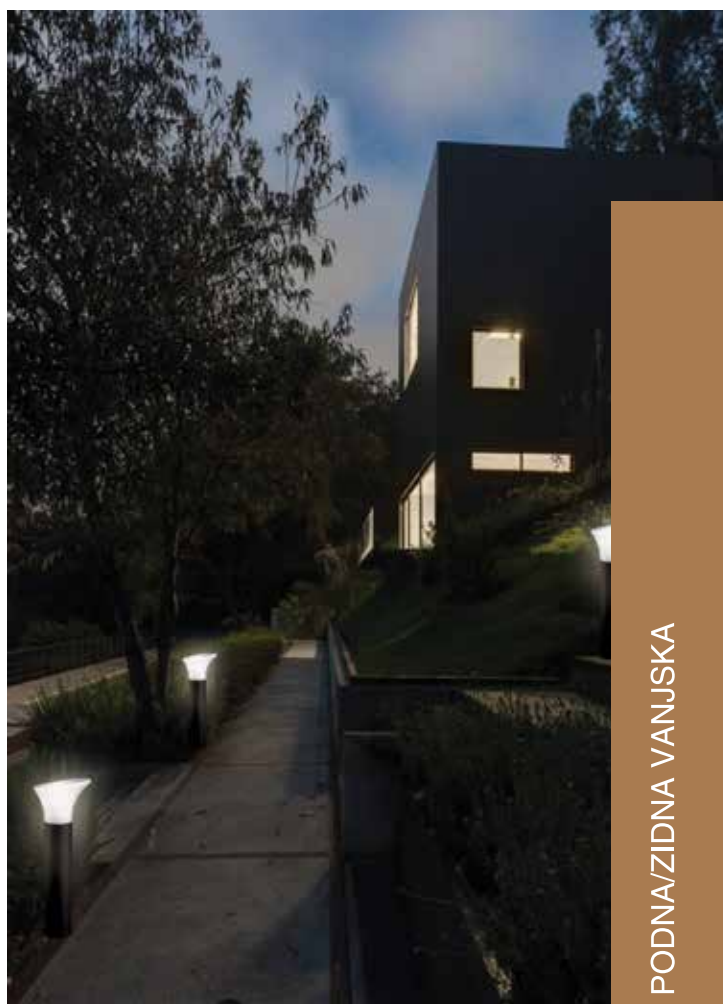

▪ PFT200W

20x20x19cm, WHITE, PE+ABS, IP65, E-27, MAX 25W



▪ PFT200G

20x20x19cm, GRANITE, PE+ABS, IP65, E-27, MAX 25W



▪ PFT601W

40x40x20cm, WHITE, PE+ABS, IP65, E-27, MAX 25W



▪ PFT601G

40x40x20cm, GRANITE, PE+ABS, IP65, E-27, MAX 25W



▪ PFT600W

20x20x22cm, WHITE, PE+ABS, IP65, E-27, MAX 25W

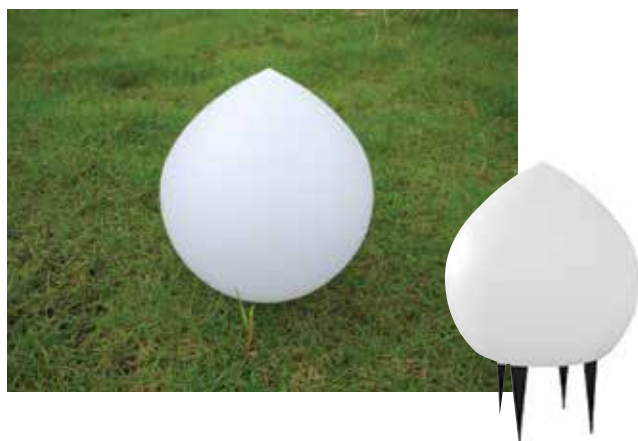

■ PFT606W

28x28x60cm, WHITE, PE+ABS, IP65, E-27, MAX 25W



■ PFT800W

20x20x28cm, WHITE, PE+ABS, IP65, E-27, MAX 25W



■ PFT809W

20x20x34cm, WHITE, PE+ABS, IP65, E-27, MAX 25W



■ PFT830W

30x30x36cm, WHITE, PE+ABS, IP65, E-27, MAX 25W



▪ 0058-WD BG

230V, 60W, 50Hz, IP44, E-27



▪ 0058-H BG

230V, 60W, 50Hz, IP44, E-27



Product Details:
Technical Specifications



▪ 061-PL-3 BG

230V, 60W, 50Hz, IP44, 3 X E-27



Product Details:
Technical Specifications



▪ 061-WD BG

230V, 60W, 50Hz, IP44, E-27



▪ 061-H BG

230V, 60W, 50Hz, IP44, E-27





▪ **0156-M-WU-2BG**

230V, 60W, 50Hz, IP44, E-27



▪ **0156-M-HBG**

230V, 60W, 50Hz, IP44, E-27



▪ **0065-M-H-BG**

230V, 60W, 50Hz, IP44, E-27



▪ **0065-M-WDBG**

230V, 60W, 50Hz, IP44, E-27



Product Details:
Technical Specifications



▪ 0047-WD
SILVER - BLACK

230V, 60W, 50Hz, IP44, E-27



▪ 0047-H
SILVER - BLACK

230V, 60W, 50Hz, IP44, E-27



▪ 0140-WD
SILVER - BLACK

230V, 60W, 50Hz, IP44, E-27



▪ 0140-H
SILVER - BLACK

230V, 60W, 50Hz, IP44, E-27



Product Details:
Technical Specifications



▪ 0107-WD BK

230V, 60W, 50Hz, IP44, E-27



▪ 0107-H BK

230V, 60W, 50Hz, IP44, E-27



▪ 0107-WD WH

230V, 60W, 50Hz, IP44, E-27



▪ 0107-H WH

230V, 60W, 50Hz, IP44, E-27



Product Details:
Technical Specifications





▪ 0107-WD BG

230V, 60W, 50Hz, IP44, E-27

▪ 0064-WD BG

230V, 60W, 50Hz, IP44, E-27

▪ 0107-H BG

230V, 60W, 50Hz, IP44, E-27

▪ 0064-H BG

230V, 60W, 50Hz, IP44, E-27



Product Details:
Technical Specifications



▪ 0108-H DG

230V, 60W, 50Hz, IP44, E-27



▪ 0108-WD DG

230V, 60W, 50Hz, IP44, E-27



▪ 0097-H RT

230V, 60W, 50Hz, IP44, E-27



▪ 0097-WD RT

230V, 60W, 50Hz, IP44, E-27





▪ 0092WD TC

230V, 60W, 50Hz, IP44, E-27



▪ 0092WD BK

230V, 60W, 50Hz, IP44, E-27



▪ 0092-H TC

230V, 60W, 50Hz, IP44, E-27



▪ 0092-H BK

230V, 60W, 50Hz, IP44, E-27



▪ 0022-H VG

230V, 60W, 50Hz, IP44, E-27



▪ 0022-H BG

230V, 60W, 50Hz, IP44, E-27



▪ 0006-H RT

230V, 60W, 50Hz, IP44, E-27



▪ 0006-WD RT

230V, 60W, 50Hz, IP44, E-27



▪ 0022-WD VG

230V, 60W, 50Hz, IP44, E-27



▪ 0022-S-PL-3 BG

230V, 60W, 50Hz, IP44, 3 X E-27



▪ 0006-S-PL-3 RT

230V, 60W, 50Hz, IP44, 3 X E-27



▪ 0022-WD BG

230V, 60W, 50Hz, IP44, E-27



Product Details:
Technical Specifications



▪ XTY-17031
MATT BLACK

450x780mm, 1xE27



▪ XTY-17031-PS
MATT BLACK

365x3000mm, 1xE27



▪ XTY-17013-WD
MATT BLACK

360x625mm, 1xE27



▪ XTY-17013-PL2
MATT BLACK

760x3200mm, 2xE27



▪ XTY-17012-M-W
MATT BLACK

350x630mm, 1xE27



▪ XTY-17012-PS
MATT BLACK

380x3200mm, 1xE27





▪ 4101 BLACK | WHITE

220~240V, 60W, 50Hz, IP43, E-27



Product Details:
Technical Specifications

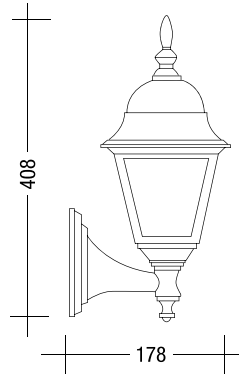

▪ 4102 WHITE | BLACK

220~240V, 60W, 50Hz, IP43, E-27

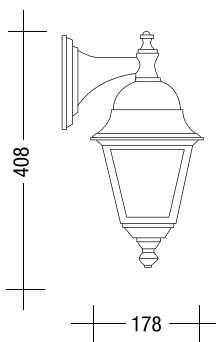

▪ 4105 WHITE | BLACK

220~240V, 60W, 50Hz, IP43, E-27

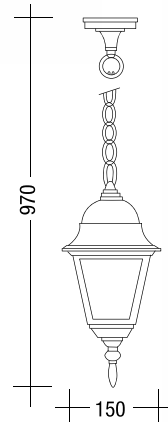

Product Details:
Technical Specifications

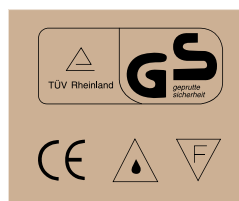

▪ 4210 BLACK | WHITE

220~240V, 100W, 50Hz, IP43, E-27

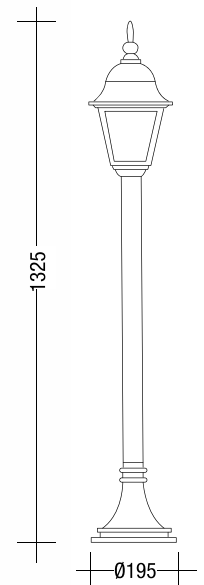

▪ 6101 GB | WHITE | BLACK

220~240V, 60W, 50Hz, IP43, E-27



Product Details:
Technical Specifications

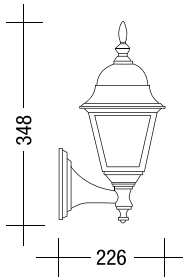

▪ 6102 WHITE | BLACK | GB

220~240V, 60W, 50Hz, IP43, E-27



Product Details:
Technical Specifications

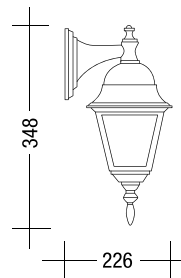

▪ 6105 BLACK | WHITE | GB

220~240V, 60W, 50Hz, IP43, E-27



Product Details:
Technical Specifications

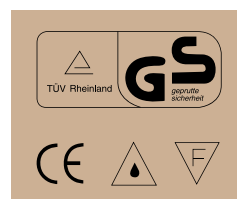
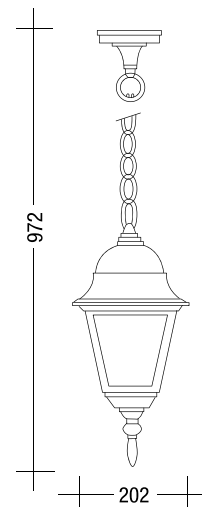

▪ 6205 BLACK
| WHITE | GB

220~240V, 100W, 50Hz, IP43, E-27



Product Details:
Technical Specifications

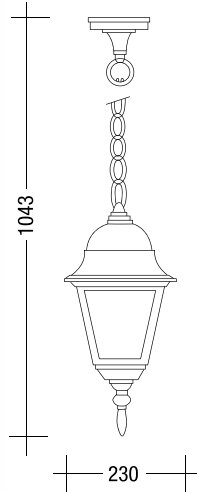

▪ 6202 GB
| BLACK | WHITE

220~240V, 100W, 50Hz, IP43, E-27

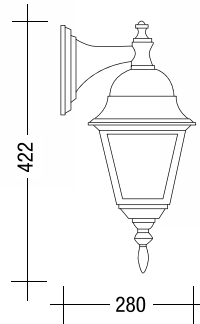

▪ 6201 WHITE
| GB | BLACK

220~240V, 100W, 50Hz, IP43, E-27



▪ 6213 BLACK
| WHITE | GB

220~240V, 60W, 50Hz, IP43, E-27

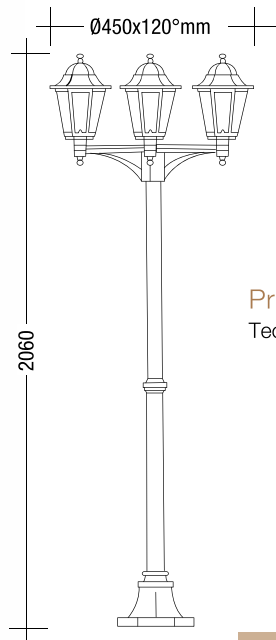

Product Details:
Technical Specifications

▪ 6210 BLACK
| WHITE | GB

220~240V, 60W, 50Hz, IP43, E-27

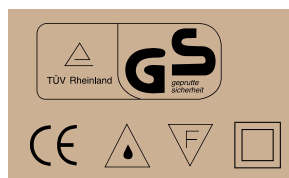
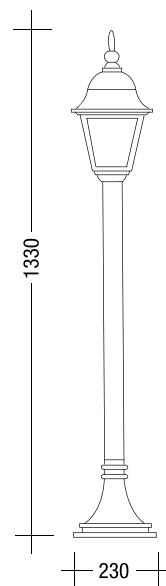

▪ LED-BLS-FL-10W
4000K-800lm-IP65



▪ LED-BLS-FL-20W
4000K-1600lm-IP65



▪ LED-BLS-FL-30W
4000K-2400lm-IP65



▪ LED-BLS-FL-50W
4000K-4000lm-IP65



Product Details:
Technical Specifications

TUV CE, RoHS, LED Floodlight with glass surface,
Die-cast aluminium hosting, Tempered glass
with H05RN-3G 1.00mm² rubble cable, 15cm

Description	LED-BLS-FL-10W	LED-BLS-FL-20W	LED-BLS-FL-30W	LED-BLS-FL-50W
Wattage (W)	10	20	30	50
CRI (Ra)	80	80	80	80
CCT	4000K	4000K	4000K	4000K
BEAM ANGLE	120°	120°	120°	120°
lm/W	80	80	80	80
DIM. mm	115x106x35	145x127x35	185x175x40	210x203x45
Im	800	1600	2400	4000
PF	>0.5	>0.5	>0.9	>0.9
Input	AC220-240V	AC220-240V	AC220-240V	AC220-240V
Driver	Linear	Linear	Linear	Linear
LED	SMD2835	SMD2835	SMD2835	SMD2835
LED QTY	15	28	42	56
IP	IP65	IP65	IP65	IP65

▪ LED-BLS-FL-10W-PIR
4000K-800lm-IP54



▪ LED-BLS-FL-20W-PIR
4000K-1600lm-IP54



▪ LED-BLS-FL-30W-PIR
4000K-2400lm-IP54



▪ LED-BLS-FL-50W-PIR
4000K-4000lm-IP54



Product Details:
Technical Specifications

TUV CE, RoHS, LED Floodlight with glass surface,
Die-cast aluminium hosting, Tempered glass
with H05RN-3G 1.00mm² rubble cable, 15cm

Description	LED-BLS-FL-10W PIR	LED-BLS-FL-20W PIR	LED-BLS-FL-30W PIR	LED-BLS-FL-50W PIR
Wattage (W)	10	20	30	50
CRI (Ra)	80	80	80	80
CCT	4000K	4000K	4000K	4000K
BEAM ANGLE	120°	120°	120°	120°
lm/W	80	80	80	80
DIM. mm	119x43x158	146x44x173	185x45x197	207x55x228
Im	800	1600	2400	4000
PF	>0.5	>0.5	>0.9	>0.9
Input	AC220-240V	AC220-240V	AC220-240V	AC220-240V
Driver	Linear	Linear	Linear	Linear
LED	SMD2835	SMD2835	SMD2835	SMD2835
LED QTY	15	28	42	56
IP	IP54	IP54	IP54	IP54

▪ SD-F012-SMD-50W

▪ SD-F012-SMD-150W



▪ SD-F012-SMD-100W



Product Details:
Technical Specifications

Item	Dimension (mm)	Lumen	LED	CCT	Beam Angle (°)	Power (W)	V/Hz
SD-F012-SMD-50W	250x210x60	120-140lm/W	SMD5730 EPISTAR	4000K	120°	50W	85-265V/50-60Hz
SD-F012-SMD-100W	295x255x80	120-140lm/W	SMD5730 EPISTAR	4000K	120°	100W	85-265V/50-60Hz
SD-F012-SMD-150W	360x310x85	120-140lm/W	SMD5730 EPISTAR	4000K	120°	150W	85-265V/50-60Hz





▪ SD-F001 RGB-10IR

10W RGB LED Flood Light

▪ SD-F001RGB-20IR

20W RGB LED Flood light



Product Details:
Technical Specifications

Artikl	SD-F001 RGB
Lumen	80-90lm/W
LED	COB, Epistar chip
Material	aluminum+Glass
Beam angle	120°
Volt	85-265V
Frequency	50-60Hz

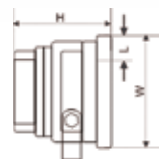

▪ YDSP140701E-10W

▪ YDSP140701E-20W

▪ YDSP140701E-10W-RGB



Product Details:
Technical Specifications

Description	YDSP140701E-10W	YDSP140701E-20W	YDSP140701E-10W-RGB
Power (W)	10	20	10W RGB
Material	Body: Aluminium	Body: Aluminium	Body: Aluminium
Color Temp.	4000K	4000K	RGB
Lumen Output (lm)	750	1500	-
Dimension D*L (mm)	133*104*176	138*124*213	133*104*176
Beam Angle (°)	110°	110°	110°
Input	100-240VAC	100-240VAC	100-240VAC
IP	65	65	65
IK08 Anti-impact	IK08 Anti-impact	IK08 Anti-impact	IK08 Anti-impact
Color	Shinny white	Shinny white	Shinny white

▪ SD-ST008-40W



▪ SD-ST008-60W



▪ SD-ST008-90W



▪ SD-ST008-120W



Product Details:

Technical Specifications

Description	SD-ST008-40W	SD-ST008-60W	SD-ST008-90W	SD-ST008-100W
VOLT/HZ	220/240V	220/240V	220/240V	220/240V
PF	>0.9	>0.9	>0.9	>0.9
CCT	4000K	4000K	4000K	4000K
BEAM ANGLE	80x140°	80x140°	80x140°	80x140°
WATT	40	60	90	120
DIMENSION mm	350x115x52	430x150x62	450x150x62	565x180x72

▪ LEDA URBAN 1S



▪ LEDA URBAN 1M

▪ LEDA URBAN L



Product Details: Technical Specifications

	Napajanje	Snaga	Faktor snage	Temp. svj.	Ra	Svjetlosni tok (4000K)	Efikasnost svjetiljke	Životni vijek LED-LM80	Radna temperatura	IK stupanj otp. na udarce
LEDA URBAN 1S	220-240VAC, 50Hz	20-40W	>0.95	3500-5000K	>80	2200-4400lm	>85lm/W	>50000h	-20 do +50°C	IK10
LEDA URBAN 1M	220-240VAC, 50Hz	50-90W	>0.95	3500-5000K	>80	5500-9900lm	>85lm/W	>50000h	-20 do +50°C	IK10
LEDA URBAN L	220-240VAC, 50Hz	100-160W	>0.95	3500-5000K	>80	11000-17600lm	>85lm/W	>50000h	-20 do +50°C	IK10

	IP stupanj vodootpornost	Kućište	Montaža	Dimenzije	Masa	Certifikati	Regulacija
LEDA URBAN 1S	IP66	Ekstrudirani aluminiј	2x M8 vijci	455x81x76mm	2.0kg	EMC,LVD,IK10,IP66,CE	1-10V
LEDA URBAN 1M	IP66	Ekstrudirani aluminiј	2x M8 vijci	703x262x90mm	4.5kg	EMC,LVD,IK10,IP66,CE	1-10V
LEDA URBAN L	IP66	Ekstrudirani aluminiј	2x M8 vijci	582x285x90mm	9.0kg	EMC,LVD,IK10,IP66,CE	1-10V



- O 1x18W
- O 2x18W



- O 1x36W
- O 2x36W



- O 1x58W
- O 2x58W



Product Details:
Technical Specifications

Model	L	B	H
O 1x18W	662	81	93
O 2x18W	662	130	93
O 1x36W	1270	81	93
O 2x36W	1270	130	93
O 1x58W	1562	81	93
O 2x58W	1562	130	93

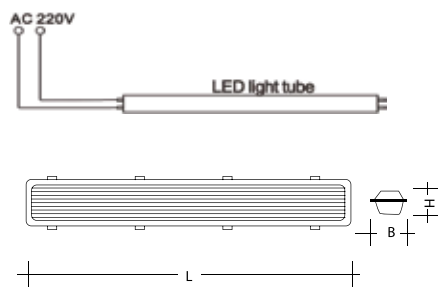

PAŽNJA!

Kučičšte je namijenjeno isključivo led cijevima s priključnim kontaktima na jednoj strani!



- LED-TPL-SLIM-0.6M
220-240V 18W

- LED-TPL-SLIM-1.2M
220-240V 36W

Product Details:
Technical Specifications

Description	LED-TPL-SLIM-0.6M 220-240V 18W	LED-TPL-SLIM-1.2M 220-240V 36W
Power (W)	18	36
IP	65	65
PF	≥ 0.9	≥ 0.9
Lumen (lm)	≥1300	≥2600
Color Temp.	4000K	4000K
Color Rendering (Ra)	≥80	≥80
Beam Angle	120°	120°
Warranty (years)	2	2
EMC	✓	✓
LVD	✓	✓
Dimension (mm)	625x71x30.5	1225x71x30.5
Body Material	PC+ALU	PC+ALU
Diffuser	PC	PC



▪ L 818 611 SY2 x 18W



▪ L 836 601 SY1 x 36W

▪ L 836 611 SY2 x 36W



▪ L 858 601 SY1 x 58W

▪ L 858 611 SY2 x 58W



ELECTRONIC BALLAST

Product Details:

Technical Specifications

Model	L	B	H
L 818 611 SY2 x 18W	662	130	93
L 836 601 SY1 x 36W	1270	81	93
L 836 611 SY2 x 36W	1270	130	93
L 858 601 SY1 x 58W	1562	81	93
L 858 611 SY2 x 58W	1562	130	93

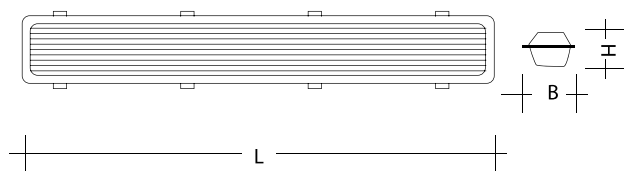

▪ SG-623579 PRIMO GRAPHITE

LED 20W 3000K



Product Details:
Technical Specifications

20W LED integrirani
230V
3000K
RA>80
IK10
IP65

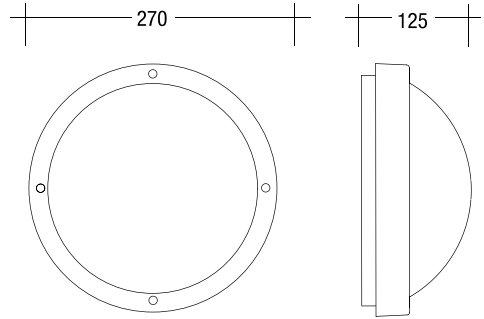

IK10  IP65 CE  

▪ SG-633864 CANTO GRAPHITE

LED 25W 3000K



Product Details:
Technical

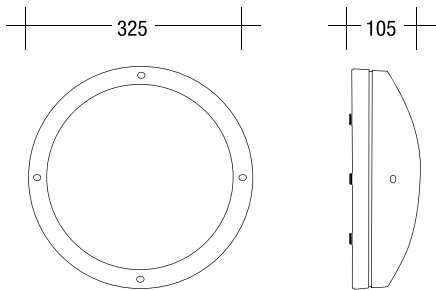

25W LED integrirani
230V
3000K
RA>80
IK10
IP65

IK10  IP65

CE 

▪ 1503 BOX WHITE, BLACK

220~240V, 60W, 50Hz, IP54, E-27

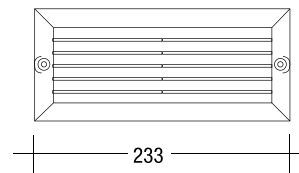

▪ TO1554 GREY | BLACK | WHITE

220~240V, 60W, 50Hz, IP54, E-27

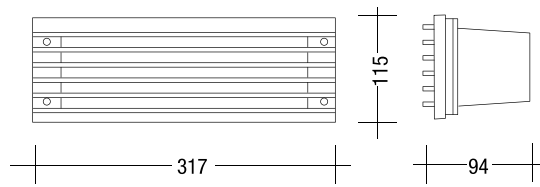

▪ 72141

ZIDNA UGRADBENA IP65

Product Details:
Technical Specifications



Model	72141
Size	Ø80mm
Light source	1W LEDs
Material	Aluminium
Protection class	IP65
Voltage	230V/AC

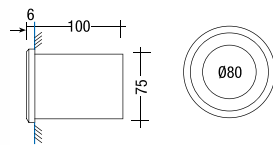

▪ 72421

ZIDNA UGRADBENA IP65

Product Details:
Technical Specifications



Model	72421
Size	40x40mm
Light source	1W LEDs
Material	Aluminium
Protection class	IP65
Voltage	230V/AC

▪ P6001A

WALL LAMP



Product Details:
Technical Specifications

Model:	P6001A WH	P6001A ANTR. GREY	P6001A MATT SILV.
Wattage:	1,5W	1,5W	1,5W
Voltage:	230V	230V	230V
IP:	65	65	65
Dimension:	Ø75mm	Ø75mm	Ø75mm
AC:	220V	220V	220V



▪ 2004 BLACK

220~240V, 100W, 50Hz, IP54, E-27



Product Details:
Technical Specifications

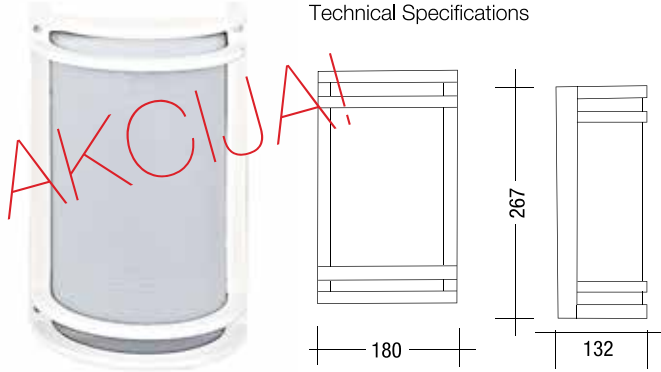

▪ 2007 WHITE | BLACK

220~240V, 100W, 50Hz, IP54, E-27



Product Details:
Technical Specifications

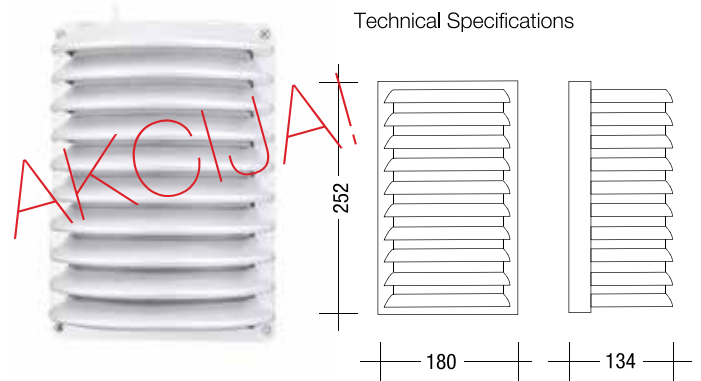

▪ 62741-A crna MAXI PC

IP65 E-27 100W PC



Product Details:
Technical Specifications

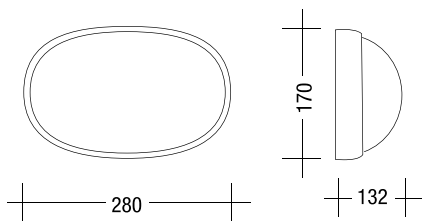

▪ 62750-C bijela MAXI PC

IP65 E-27 100W PC



Product Details:
Technical Specifications

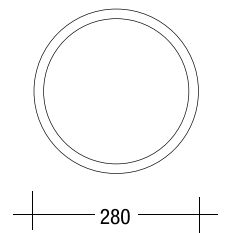

▪ 62751-C crna MAXI PC

IP65 E-27 100W PC



▪ 1205 WHITE

220~240V, 100W, 50Hz, IP54, E-27



Product Details:
Technical Specifications

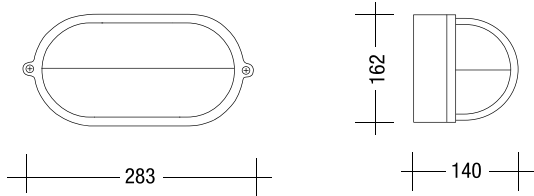

▪ 1201 GREY | WHITE

220~240V, 100W, 50Hz, IP54, E-27



Product Details:
Technical Specifications

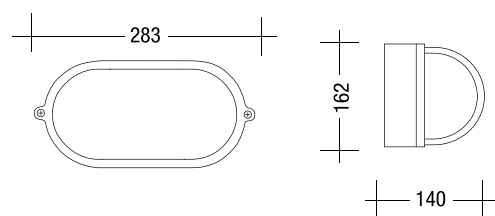

▪ 1208 BLACK

220~240V, 100W, 50Hz, IP54, E-27

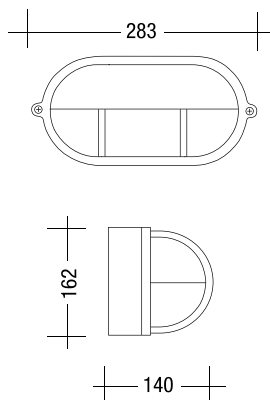

▪ 1102 WHITE

220~240V, 100W, 50Hz, IP54, E-27

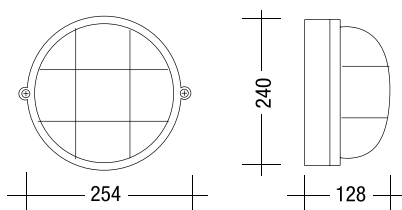

▪ 1105 GREY | WHITE

220~240V, 100W, 50Hz, IP54, E-27

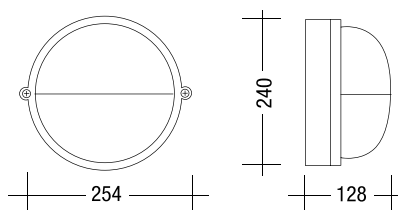

▪ 2201 BLACK | GREY | WHITE

220~240V, 100W, 50Hz, IP54, E-27



Product Details:
Technical Specifications

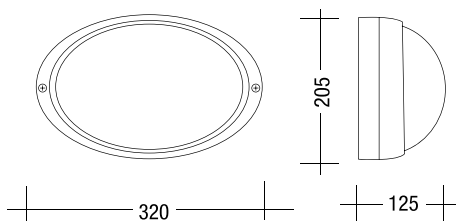

▪ 2202 BLACK

220~240V, 100W, 50Hz, IP54, E-27



Product Details:
Technical Specifications

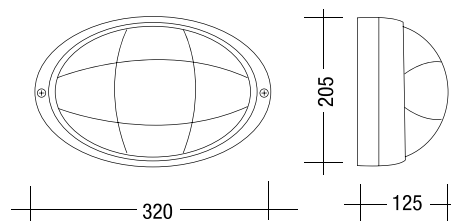

▪ 2032 GREY

220~240V, 75W, 50Hz, IP54, E-27



Product Details:
Technical Specifications

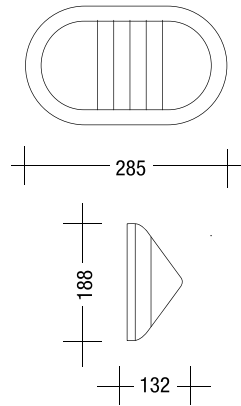

▪ 2402 BLACK

220~240V, 60W, 50Hz, IP54, E-27



Product Details:
Technical Specifications

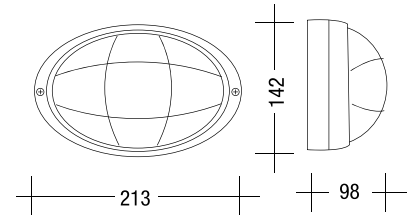

▪ 2074 WHITE | GREY

220~240V, 75W, 50Hz, IP54, E-27



Product Details:
Technical Specifications

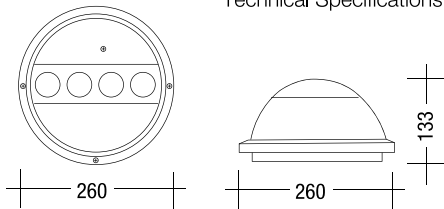

▪ 2304 BLACK | WHITE

220~240V, 60W, 50Hz, IP54, E-27



Product Details:
Technical Specifications

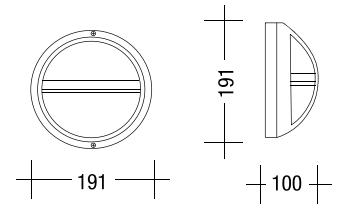

▪ 3011 BLACK | GREY | WHITE

12V, 20W, 50Hz, IP54, G4



Product Details:
Technical Specifications

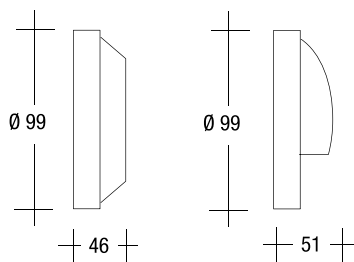

▪ 3012 BLACK

12V, 20W, 50Hz, IP54, G4



▪ PK-290TC

MATT ANTRACITE GREY



IP66

Product Details:
Technical Specifications

Model:	PK-290TC
Color:	matt antracite grey
Wattage:	15W
Voltage:	AC220-240V
Lumen:	1250lm
CRI:	>85
PF:	>0.8
CCT:	4000K
Size:	290*290*100
Material:	PC+PC
Driver:	isolated driver
Warranty:	3 years
Certificate:	TUV CE RoHS

▪ LD8020

LED 220-240V, CREE XBD, 9x1W, 4000K, IP65

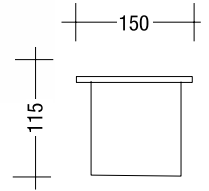

Product Details:
Technical Specifications

▪ PK-300TA SENSOR

MATT ANTRACITE GREY



▪ PK-200TB

MATT WHITE



▪ PK-200TB

MATT ANTRACITE GREY



Product Details:
Technical Specifications

Model:	PK-300TA	PK-200TB	PK-200TB
Color:	matt antracite grey	matt white	matt antracite grey
Wattage:	12W	10W	10W
Voltage:	AC220-240V	AC220-240V	AC220-240V
Lumen:	900lm	600lm	600lm
CRI:	>85	>85	>85
PF:	>0.8	>0.8	>0.8
CCT:	4000K	4000K	4000K
Size:	300*300*100	290*200*100	290*200*100
Material:	PC+PC	PC+PC	PC+PC
Driver:	isolated driver	isolated driver	isolated driver
Warranty:	3 years	3 years	3 years
Certificate:	TUV CE RoHS	TUV CE RoHS	TUV CE RoHS



▪ PK-200TA

MATT ANTRACITE GREY



▪ PK-300T

MATT ANTRACITE GREY



Product Details:
Technical Specifications

Model:	PK-200TA	PK-300T	PK-300TA	PK-300TA
Color:	matt antracite grey	matt antracite grey	matt white	matt antracite grey
Wattage:	12W	15W	12W	12W
Voltage:	AC220-240V	AC220-240V	AC220-240V	AC220-240V
Lumen:	950lm	840lm	900lm	900lm
CRI:	>85	>85	>85	>85
PF:	>0.8	>0.8	>0.8	>0.8
CCT:	4000K	4000K	4000K	4000K
Size:	290*200*100	300*300*100	300*300*100	300*300*100
Material:	PC+PC	PC+PC	PC+PC	PC+PC
Driver:	isolated driver	isolated driver	isolated driver	isolated driver
Warranty:	3 years	3 years	3 years	3 years
Certificate:	TUV CE RoHS	TUV CE RoHS	TUV CE RoHS	TUV CE RoHS

IP66

▪ PK-300TA

MATT WHITE



▪ PK-300TA

MATT ANTRACITE GREY



▪ LD0601-C

LED 220-240V, CREE XP-E, 3X2W, 4000K, IP65



Product Details:
Technical Specifications

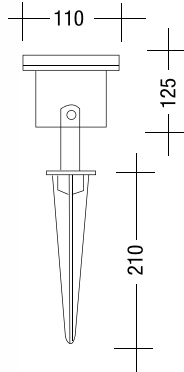

▪ TL3012 BLACK | WHITE

12V, 35W, 50Hz, IP68, G5,3



Product Details:
Technical Specifications

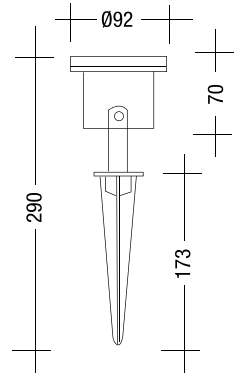

▪ LG3623 WHITE

230V, 100W, 50Hz, IP44, E-27



Product Details:
Technical Specifications

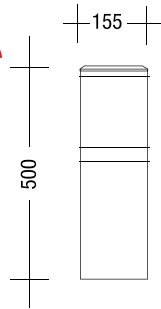

AKCIJA!

▪ 3606 WHITE

220-240V, 60W, 50Hz, IP43, E-27



Product Details:
Technical Specifications

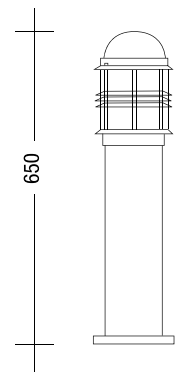

AKCIJA!

▪ LG3624 BLACK | GREY | WHITE

230V, 100W, 50Hz, IP44, E-27



Product Details:
Technical Specifications

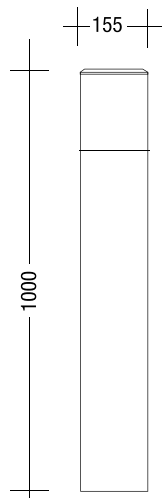

AKCIJA!

▪ TO3908A WHITE

230V, 60W, 50Hz, IP43, E-27



Product Details:
Technical Specifications

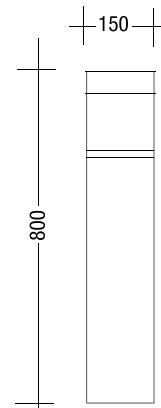

AKCIJA!

■ PD-PIR500H 500W WHITE | BLACK

Infrared sensor lamp



180° / 140°
Direction angle

Product Details:
Technical Specifications

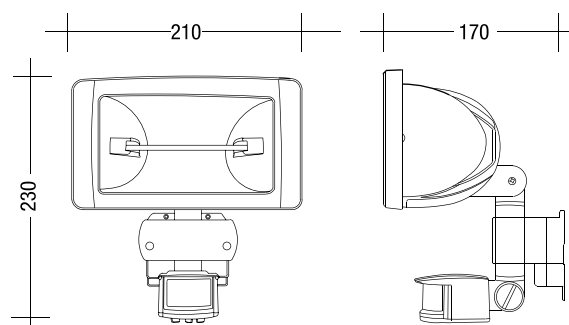

▪ SD-F013-MS-10DW

▪ SD-F013-MS-30DW



▪ SD-F013-MS-20DW



Product Details:
Technical Specifications

Item	Dimension (mm)	Lumen	LED	CCT	Beam Angle (°)	Power (W)	V/Hz
SD-F013-MS-10DW	120x127x40	120-140lm/W	SMD5730 EPISTAR	4000K	120°	10	85-265V/50-60Hz
SD-F013-MS-20DW	184x184x64	120-140lm/W	SMD5730 EPISTAR	4000K	120°	20	85-265V/50-60Hz
SD-F013-MS-30DW	227x227x80	120-140lm/W	SMD5730 EPISTAR	4000K	120°	30	85-265V/50-60Hz
SD-F013-MS-50DW	290x290x90	120-140lm/W	SMD5730 EPISTAR	4000K	120°	50	85-265V/50-60Hz

**MS u oznaci predstavlja 5.8GHz Microwave senzor



▪ SD-F013-MS-50DW



▪ SD-F001-10DW 12V

10W LED Flood light

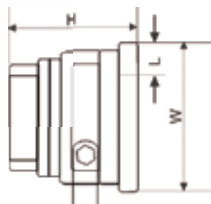

Product Details:
Technical Specifications

Artikl	SD-F001-10DW
Lumen	80-90lm/W
LED	COB, Epistar chip
Material	aluminum+Glass
CCT	4000K
Beam angle	120°
Volt	12V
Frequency	50-60Hz
Size	113x85x80mm

▪ SD-F001-20DW 12V

20W LED Flood light

▪ SD-F001-30DW 12V

30W LED Flood light

▪ SD-F001-50DW 12V

50W LED Flood light

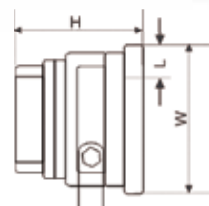

Product Details:
Technical Specifications

Artikl	SD-F001
Lumen	80-90lm/W
LED	COB, Epistar chip
Material	aluminum+Glass
CCT	4000K
Beam angle	120°
Volt	12V
Frequency	50-60Hz

Model	20DW	30DW	50DW
L (mm)	180	223	286
W(mm)	140	183	232
H (mm)	95	112	125



■ SD-F013SMD-10 DW

10W SMD flat LED Flood light

■ SD-F013SMD-10WW

10W SMD flat LED Flood light

■ SD-F013SMD-30WW

10W SMD flat LED Flood light

■ SD-F013SMD-50WW

10W SMD flat LED Flood light



AKCIJA!

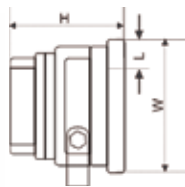

Product Details:
Technical Specifications

Artikl	SD-F013SMD
Lumen	80-90lm/W
LED	COB, Epistar chip
Material	aluminum+Glass
CCT	3000K
Beam angle	120°
Volt	85-265V
Frequency	50-60Hz

Model	10WW	30WW	50WW
L (mm)	120	184	227
W(mm)	127	184	227
H (mm)	40	64	80

■ SD-F001-10DW

10W LED Flood light



AKCIJA!

■ SD-F001-50DW

50W LED Flood light



AKCIJA!

Product Details:
Technical Specifications

Artikl	SD-F001-10DW
Lumen	80-90lm/W
LED	COB, Epistar chip
Material	aluminum+Glass
CCT	4000K
Beam angle	120°
Volt	85-256V
Frequency	50-60Hz
Size	113x85x80mm

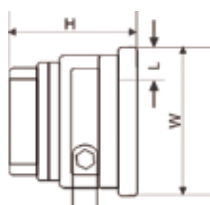

Product Details:
Technical Specifications

Artikl	SD-F001
Lumen	80-90lm/W
LED	COB, Epistar chip
Material	aluminum+Glass
CCT	4000K
Beam angle	120°
Volt	85-265V
Frequency	50-60Hz

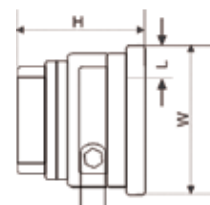

Model	50DW
L (mm)	286
W(mm)	232
H (mm)	125

▪ SD-F006-30CW

30W LED Flood light



Product Details:
Technical Specifications

Artikl	SD-F006
Lumen	80-90lm/W
LED	COB, Epistar chip
CCT	6000K IP:65
Material	aluminum+Glass
Beam angle	120°
Volt	85-265V
Frequency	50-60Hz

Dimensions:

Artikl	30CW
L (mm)	250
W(mm)	90
H (mm)	295

▪ SD-F006PIR-10CW

10W PIR LED Flood light

▪ SD-F006PIR-30CW

30W PIR LED Flood light

▪ SD-F006PIR-50CW

30W PIR LED Flood light



▪ SD-F002-100W

100W (2x50W) LED flood light, 4000K,
AC85-265v, Epistar 35 mil chip



Dimensions:

Model	SD-F002-100W
L (mm)	330
W(mm)	403
H (mm)	120

Dimensions:

Artikl	10CW	30CW	50CW
L (mm)	160	250	232
W(mm)	50	90	125
H (mm)	180	295	286

Product Details:
Technical Specifications

Artikl	SD-F006
Lumen	80-90lm/W
LED	COB, Epistar chip
CCT	6000K IP:65
Material	aluminum+Glass
Beam angle	120°
Volt	110V/220V

▪ SD-F015-70W

70W LED flood light, 4000K, AC85-265V, Epistar 38 mil chip



Product Details:
Technical Specifications

Model	SD-F015-70W
L (mm)	286
W(mm)	185
H (mm)	105

▪ LED-FL2-AC220-240V-10W

LED flood light 10W



Product Details:
Technical Specifications

Description	LED-FL2-AC220-240V-10W
Power (W)	10
IP	65
PF	>0.85
Lumen (lm)	700
Color Temp.	3000K
Color Rendering (Ra)	80
Beam Angle	140
Warranty (years)	2
EMC	✓
LVD	✓
Dimension (mm)	135*111*18.5
Body Material	Aluminium
Diffuser	Glass

▪ LED-SMD-220-240V-10W

LED flood light 10W, WHITE HOUSING



▪ LED-SMD-220-240V-30W

LED flood light 10W, WHITE HOUSING



Product Details:
Technical Specifications

Description	LED-SMD-220-240V-10W	LED-SMD-220-240V-30W
Power (W)	10	30
IP	44	44
PF	>0.9	>0.9
Lumen (lm)	800	2500
Color Temp.	6000K	6000K
Color Rendering (Ra)		
Beam Angle	120	120
Warranty (years)		
EMC	✓	✓
LVD	✓	✓
Dimension (mm)	130x150x50	170x190x70
Body Material	Aluminium	Aluminium
Diffuser	Glass	Glass

▪ SD-ST013 12W



▪ SD-ST013 40W



Product Details:
Technical Specifications

Description	SD-ST013 12W	SD-ST013 24W	SD-ST013 40W	SD-ST013 60W
LED TYPE	1W HIGH POWER	1W HIGH POWER	1W HIGH POWER	1W HIGH POWER
LED CHIP	EPISTAR 35mm	EPISTAR 35mm	EPISTAR 35mm	EPISTAR 35mm
CCT	6500K	6500K	6500K	6500K
BEAM ANGLE	80x140°	80x140°	80x140°	80x140°
WATT	12	24	40	60
LUMEN	110-120lm/W	110-120lm/W	110-120lm/W	110-120lm/W
DIMENSION mm	350x95x55	400x141x70	470x200x70	550x250x70

▪ SD-ST013 24W



▪ SD-ST013 60W

